

折叠尺寸: 58\*100mm  
 展开尺寸: 290\*100mm  
 工艺: 单色双面印刷

材质:	128g双铜
物料编号:	16050100000022
版本号:	A01
客户名称:	加雪龙
设计师:	龚婵玉
对接人:	王婷/宣章珊
时间:	2020年12月31日



## 多功能自行车支架 Multifunctional Bicycle Holder

### 说明书 User Manual

H09

#### H09 所有配件 H09 ACCESSORIES



#### 支架安装步骤 MOUNTING STEPS

##### 安装示意图 Installation Diagram

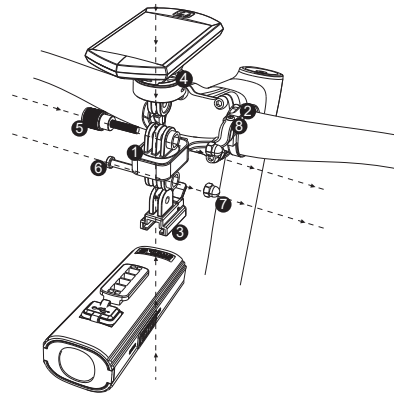

1、将配件环套在自行车车把上。  
Put the snap rings on the bicycle handlebar.

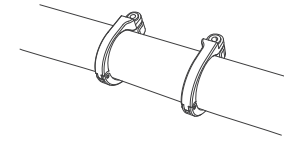

2、将支架主体安装在配件环上,用2号六角扳手将配件环螺丝拧紧。  
Mount the holder on the snap rings, and tighten the screws up with hex wrench 2.

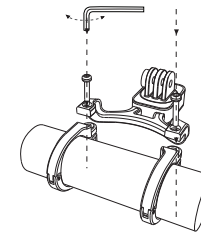

### 保修凭证 Warranty Certificate

#### 用户资料 (顾客填写)

User's Information (Filled In By User)

姓名: \_\_\_\_\_ 联系电话: \_\_\_\_\_

Name: \_\_\_\_\_ Phone: \_\_\_\_\_

邮编: \_\_\_\_\_

Zip Code: \_\_\_\_\_

地址: \_\_\_\_\_

Address: \_\_\_\_\_

购买时期: \_\_\_\_\_ 年 \_\_\_\_\_ 月 \_\_\_\_\_ 日

Purchase Date: \_\_\_\_\_ Year \_\_\_\_\_ Month \_\_\_\_\_ Date

以下由售货员填写

The Following Are Filled In By The Consignee

销售资料: \_\_\_\_\_

Sales Information:

销售单位 (加盖公章)

Sales Company (Stamped With Company Seal)

联系电话: \_\_\_\_\_

Phone: \_\_\_\_\_

地址: \_\_\_\_\_

Address: \_\_\_\_\_

就近服务指导 (顾客第一时间的联系点)

Nearby Service Guidance (Customer First Contact Point)

服务单位名称: \_\_\_\_\_

Service Unit: \_\_\_\_\_

联系电话: \_\_\_\_\_

Phone: \_\_\_\_\_

地址: \_\_\_\_\_

Address: \_\_\_\_\_

### 保修卡

- 有关售后服务事宜,请与经销商联系,正常使用出现质量问题,自购买之日起七天内包退,十五天内可免费更换本公司同一型号的产品,但产品包装不予以更换。
- 购买时间以经销商开出的发票或收据为准。
- 在下列情况下包换、保修失效,但提供有偿的维修服务:
  - 一切人为因素损坏,如非正常工作环境下使用,不按说明书使用引起的损坏等;
  - 客户自行维修改装,或未经本公司授权的单位维修;
  - 购买后因运输不良造成的损坏;
  - 本公司产品保修卡包换/保修,需服务时,请提供购机发票或收据。
  - 下述一切非正常使用情况下造成的任何损失,本公司将不承担任何责任。
    - 因用户错误使用造成安全隐患或意外事故;
    - 因不可抗力因素造成的安全隐患或事故;
    - 消费者未按说明书规定进行操作,使用非说明书上要求的配件等消耗材料造成对第三方配件的损坏及意外事故或人身伤害。
  - 无论您在何处购买本产品,均可在最近的售后服务点得到同样完善的服务,如果问题没有得到妥善解决,请致电或来函客户服务部。
  - 对以上条款的修改权及解释权归本公司所有。

#### Warranty Card

- Please contact the wholesaler for customer service. For inherent problems under correct use, we accept a return during seven days since purchase. Users are allowed to replace a new product of the same model during fifteen days since purchase, and package is excluded in the replacement.
- Purchase date is defined in accordance with the invoice or receipt made by wholesaler.
- Under the following circumstances, return and fix are both invalidated, but we offer a paid repair service.
  - All damages caused by subjective factors, such as using under abnormal conditions or against the user manual.
  - User's independent repairing and modifying or other unauthorized maintenance.
  - Damages caused by improper shipping.
- We offer return/maintenance service by presenting this card, please show your invoice or receipt when the service is needed.
- Gaciron is irresponsible for any damages caused by the following improper uses.
  - Hidden safety factors or incidents caused by user's improper operation or other accidents.
  - Hidden safety factors or incidents caused by irresistible factors.
  - Damages or accidents or injuries caused by user's independent operation against the manual or using other materials on the product which causes malfunction.
- Whenever you purchase this product, you have the total access to equivalent services from the nearest customer service center; if the problem is not solved to your satisfaction, please make a phone call to us or email to our customer service department.
- The right of modification and interpretation on the above terms is held.

3、将车灯卡扣支架/码表底座安装在支架上,并用手柄螺杆将其拧紧。  
Mount the headlight GoPro base or stopwatch base on the holder, and tighten it up with handle screw.

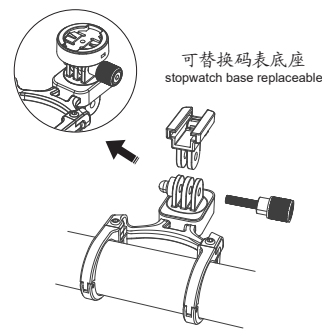

可替换码表底座  
stopwatch base replaceable

#### H09可搭配装备组合 COMBO MOUNTING OPTIONS

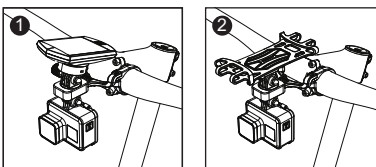

上: 码表  
Top: Garmin Stopwatch  
下: GoPro  
Bottom: GoPro Sports Camera

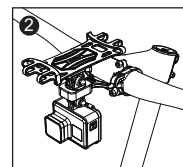

上: 加雪龙H06P手机支架  
Top: H06P Bicycle Phone Holder  
下: GoPro  
Bottom: GoPro Sports Camera

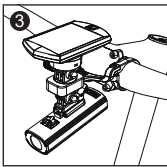

上: 码表  
Top: Garmin Stopwatch  
下: 吊装车灯  
Bottom: Bicycle Light

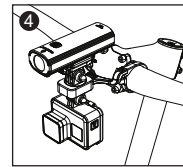

上: 车灯  
Top: Bicycle Light  
下: GoPro  
Bottom: GoPro Sports Camera

#### H09 产品参数 TECHNICAL SPECIFICATION

产品尺寸: 108\*68\*72mm  
 材质: 6061铝合金表面硬氧化+工程塑料尼龙  
 安装方式: 工具安装  
 旋转角度: 车灯卡扣支架/码表底座可调角度为100度  
 搭配使用: H06P支架(适用4.7-6.0寸屏幕)、Gaciron自行车前灯、GoPro运动相机、佳明码表、行者码表等  
 适用管径:  $\Phi 31.8-32mm$   
 产品净重:  $\approx 91g$  (含配件)  
 最大承载重量:  $< 258g$

Size: 108\*68\*72mm  
 Material: Aluminum Alloy 6061 / Engineering Plastic Nylon  
 Installation: By Tools  
 Adjustable Angle: 100° up and down (Headlight GoPro Base / Stopwatch Base)  
 Application: H06P Bicycle Phone Holder, Gaciron Bicycle Headlight, GoPro Motion Camera, Garmin Stopwatch, etc.  
 Compatible Pipe Diameter:  $\Phi 31.8-32mm$   
 Net Weight:  $\approx 91g$  (Including Accessories)  
 Max Bearing Weight:  $\leq 258g$



检验员: \_\_\_\_\_  
 Inspector \_\_\_\_\_  
 日期: \_\_\_\_\_  
 Date \_\_\_\_\_

深圳市加雪龙科技有限公司  
 Shenzhen Gaciron Technology Co., Ltd  
 公司地址: 深圳市宝安区新安街道71区建设工业园J栋众里创业社区101  
 Headquarters: Rm101, Joinin hub, J Bld. Construction Industrial Park, 71th District, Xin'an Rd, Bao'an, Shenzhen  
 全国统一售后服务热线: 0755-23322700  
 Customer Service Hotline: 86 755 23322700  
 网址: www.gaciron.com  
 Website: www.gaciron.com  
 产品执行标准: Q/JXL 005-2017  
 Product Standard: Q/JXL 005-2017  
 产地: 中国东莞  
 Made in China

